

# BALLO L809

Vejarmatur / Streetlight fixture / Straßenleuchte / Vägarmatur

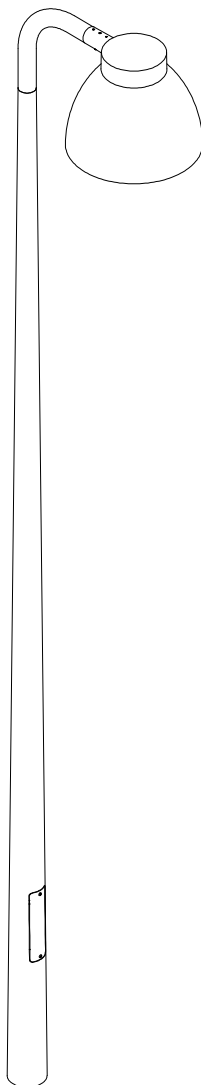

Monteringsvejledning / Mounting instructions /  
Installationsanleitung / Installationsinstruktioner

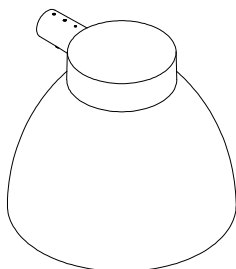
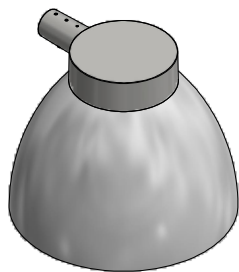

Ø454

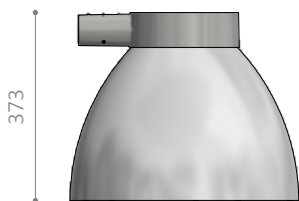

373

Værktøj / Tool / Werkzeug / Verktyg:



3 mm

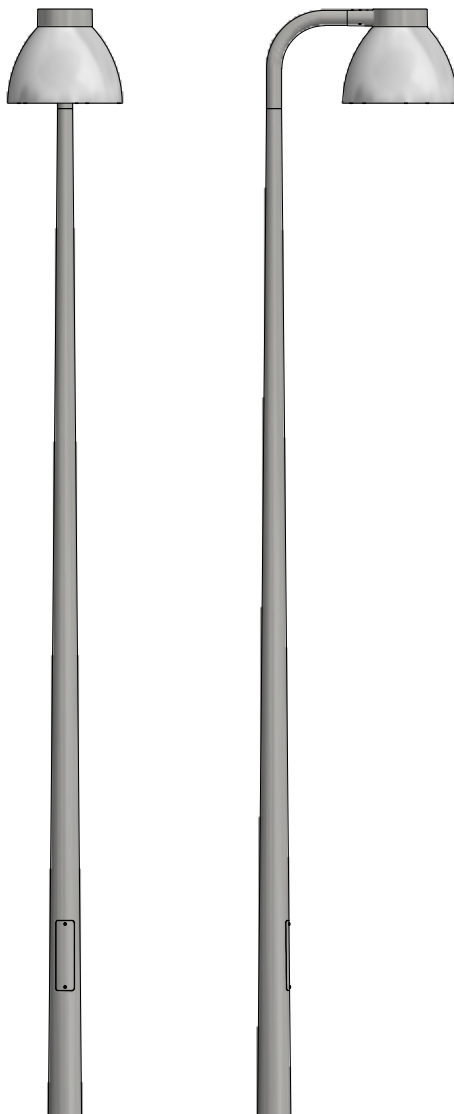

1

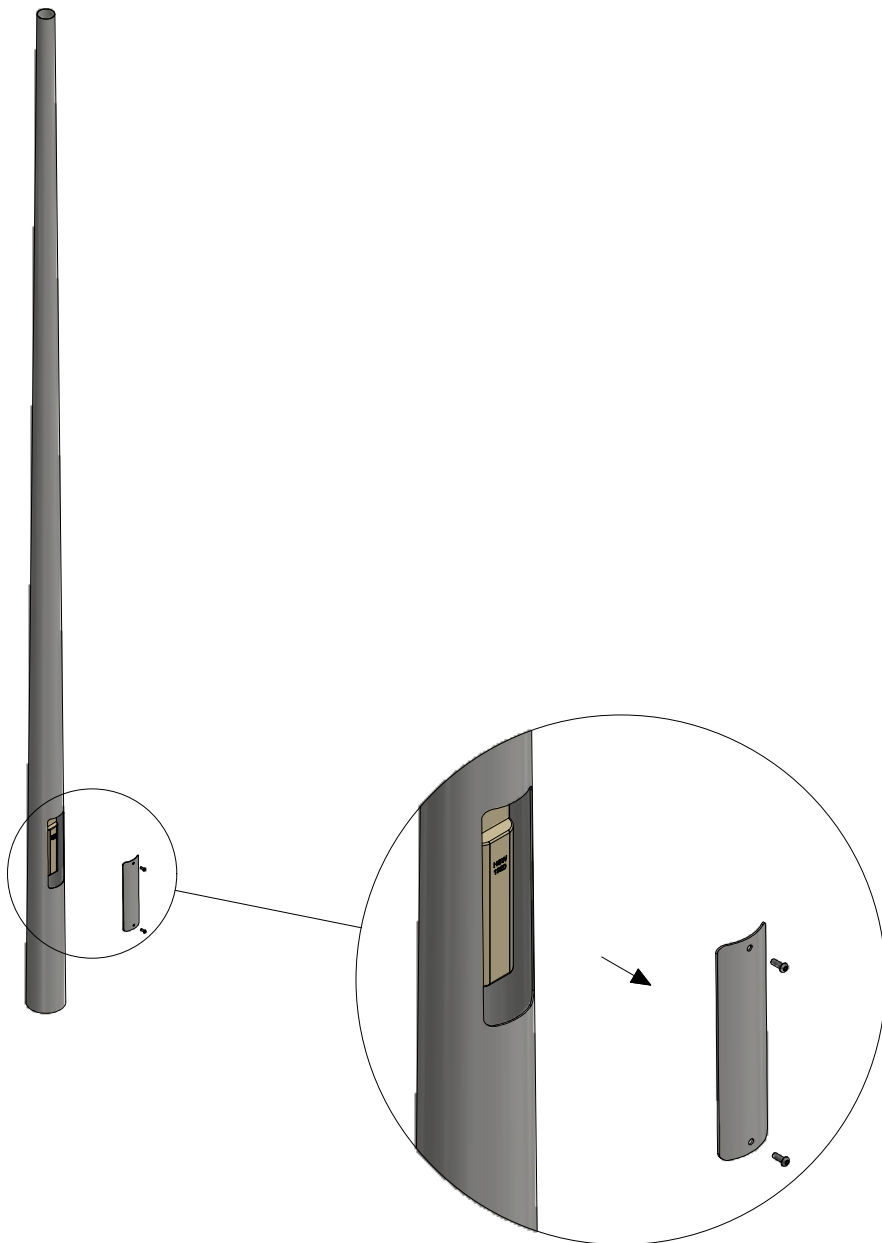

2

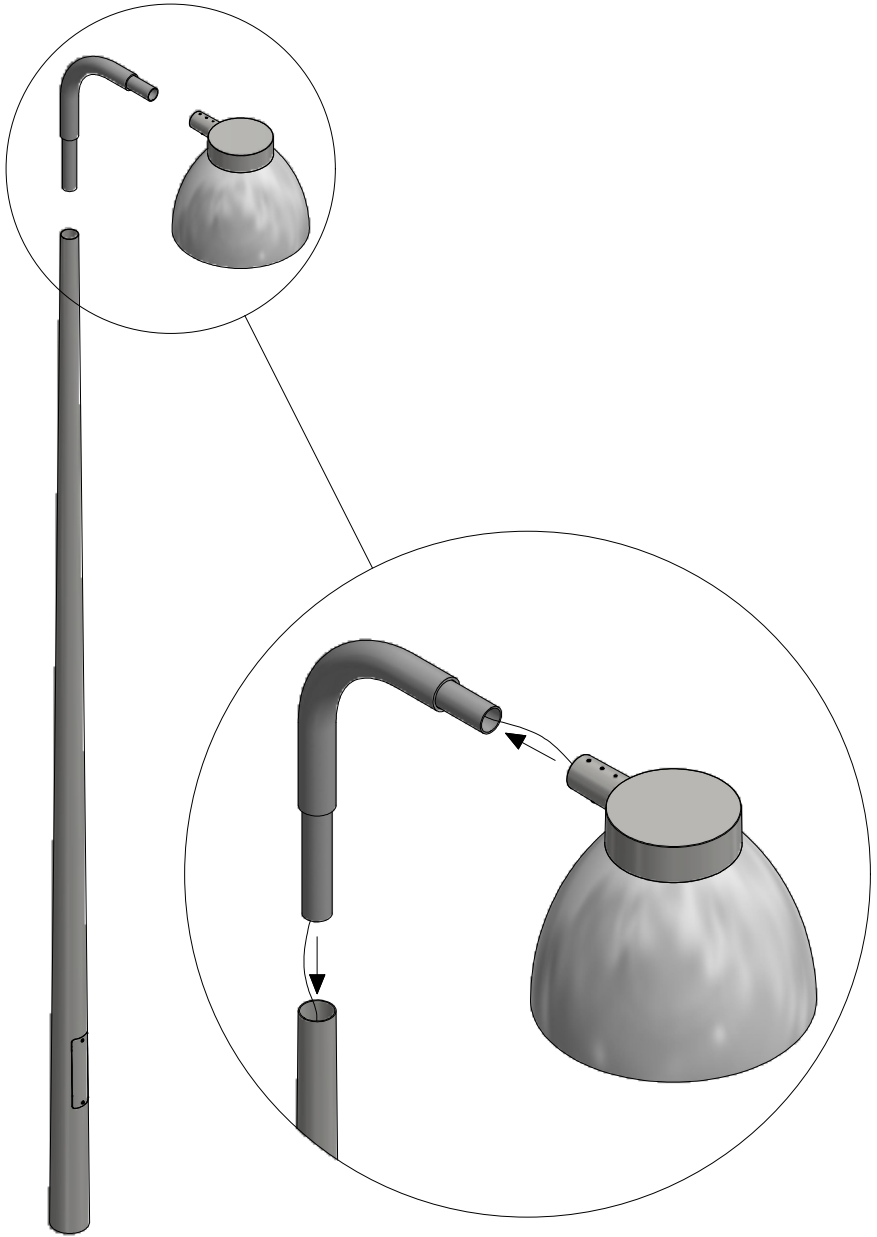

3



3 mm

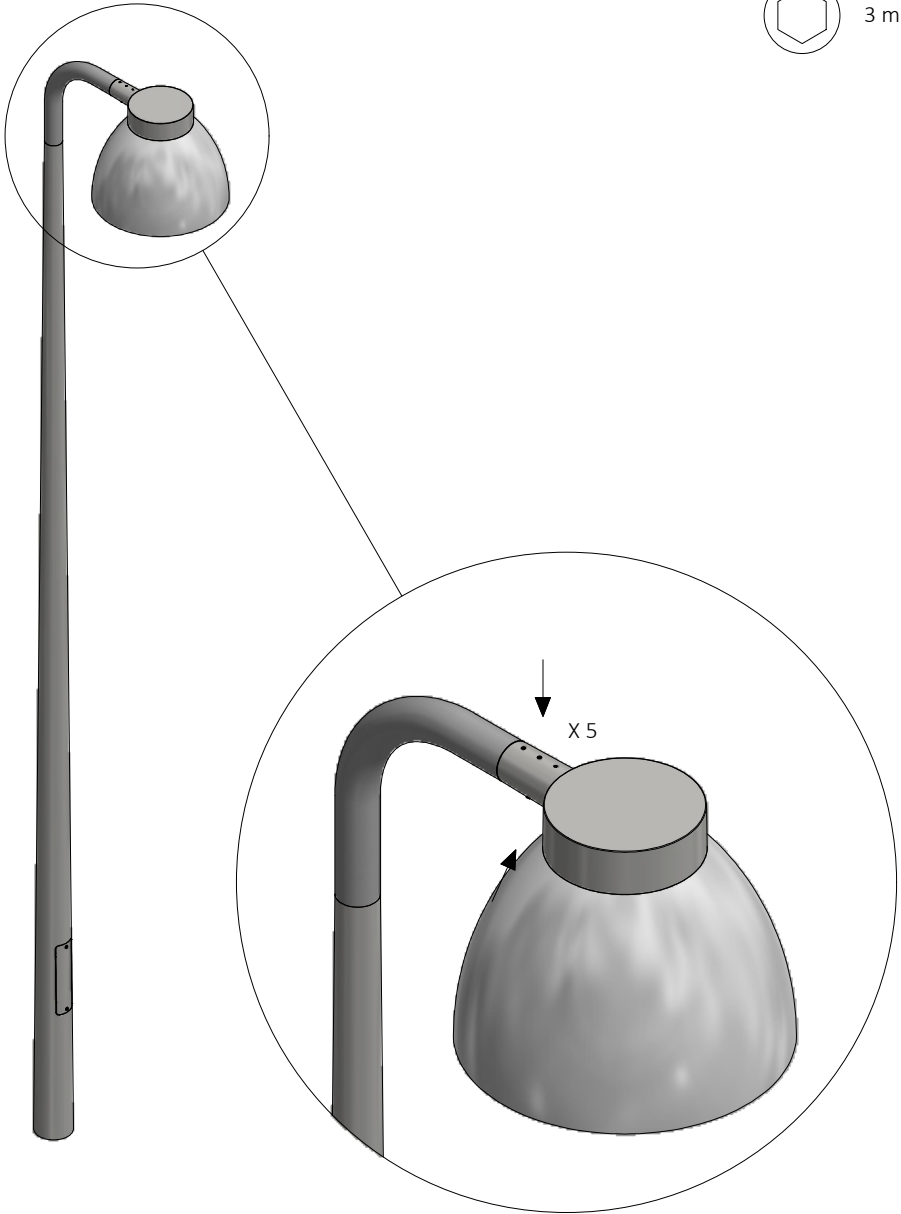

4

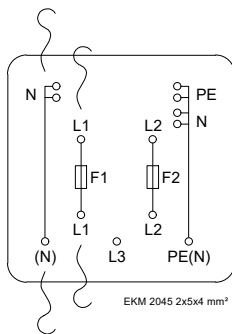
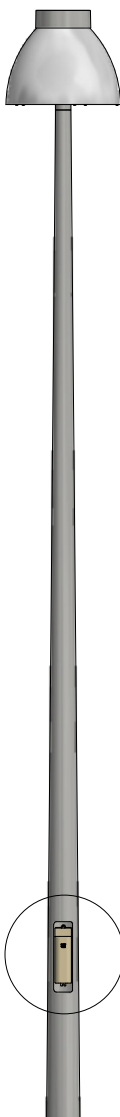



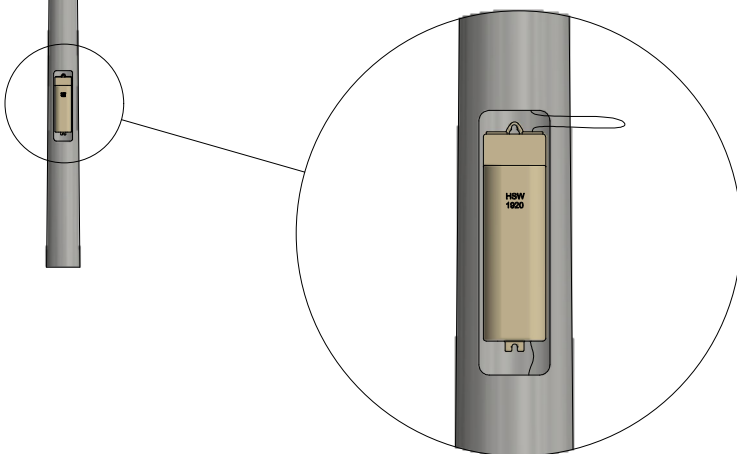



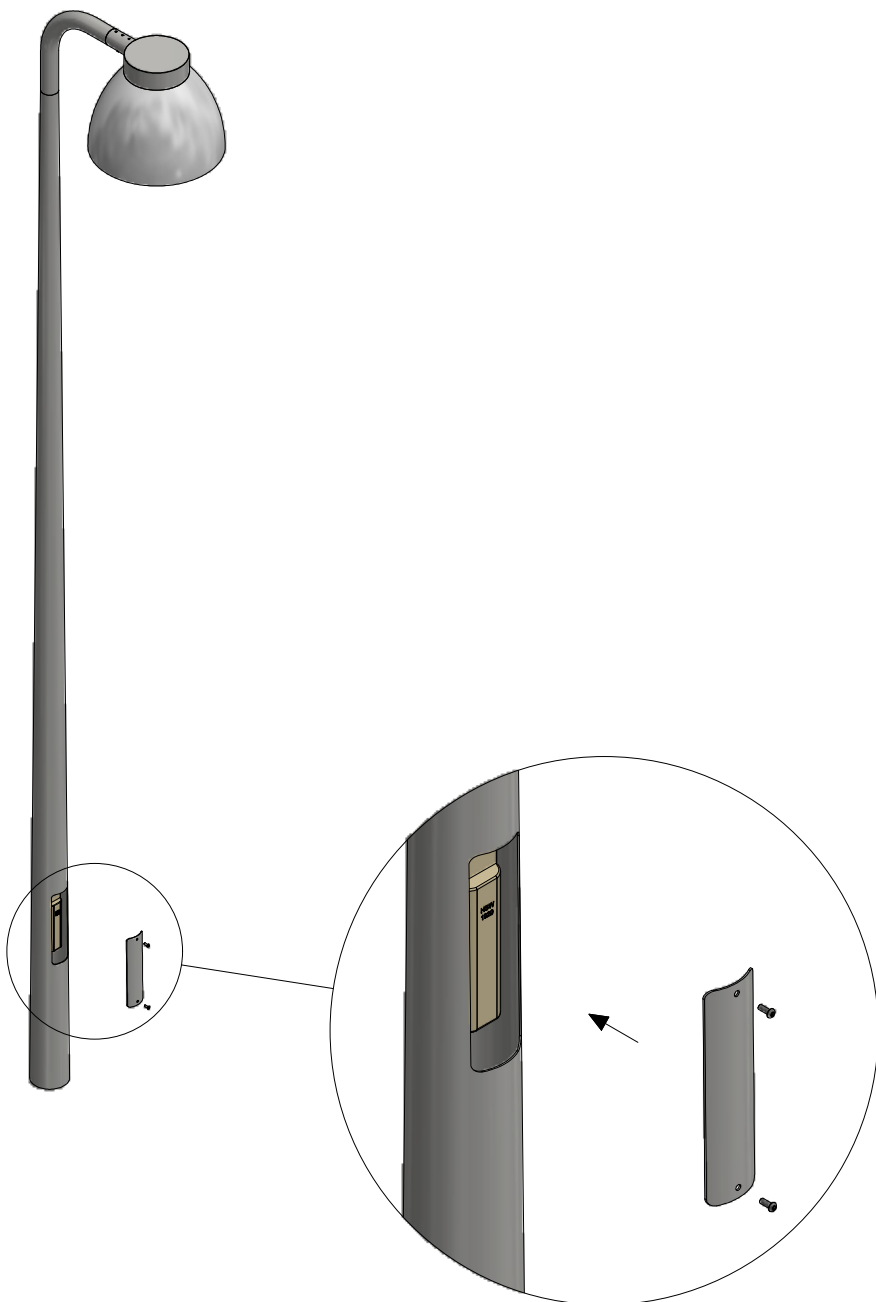



Isolationsklasse II / Insulation class II /  
Schutzklasse II / Isolationsklass II



5



			
	LED		
	220-240 V 50-60 Hz		
	Isolationsklasse II / Insulation class II / Schutzklasse II / Isolationsklass II		
	IP54		
IK	IK10		
	9,2 kg		
	Se vedligeholdelses vejledning / See maintenance instructions / Siehe Wartungsanweisungen / Se underhållsinstruktioner		
	Montering/udskiftning må kun udføres af producenten eller aut. el-installatør / Installation/replacement must only be carried out by the manufacturer or by an electrician / Die Installation/der Austausch darf nur vom Hersteller oder von einem Elektriker durchgeführt werden / Installation / utbyte får endast utföras av tillverkaren eller av en behörig elektriker		

# Lampas